

# ZL-6x0A Temperature Controller

## Instruction Manual, V4.4

### 1. Introduction

ZL-6x0A series thermostat are suitable for control of cold storage, seafood storage, water heater, and so on.

### 2. Main Function

- Cooling or heating mode
- Periodic or intellectual defrost
- Fan control
- Temperature calibration
- High/low over temp. warning
- Temp. output delay protection
- Sensors failure warning
- Buzzer warning
- External warning input

### 3. Models

4.Model	Function		
ZL-610A	Cooling/heating	Periodic defrost	
ZL-620A		Intellectual defrost	External warning input
ZL-630A		Intellectual defrost	Fan control





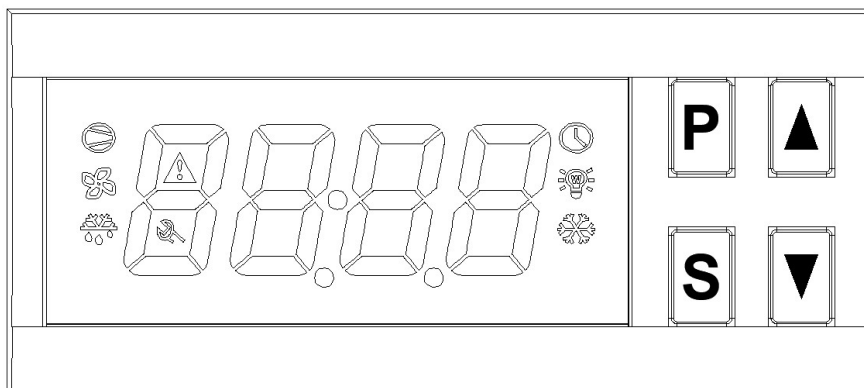

### 5. Main Specification

- Sensor wire: 1.5 meters long (sensor included)
- Sensor: NTC
- Setting range: -40~120°C
- Display range: -50~130°C
- Power supply: 185~245Vac, 50/60Hz
- Terminal wire: ≤ 2\*1.5mm<sup>2</sup>, or 1\*2.5mm<sup>2</sup>
- Load: 3A, 10A, 250Vac (resistance)
- Storage: -30~70°C
- Working: -10~45°C
- Working: 5~85%RH without dew
- Case materials: PC + ABS fire proof
- Protection level: IP65 (Front side only)
- Dimension: L78 x W34.5 x D71 (mm)
- Installation drilling: L71 x W29 (mm)

### 6. Operation



### 5.1 Display Icon

Icon	Function	On	Off	Blink
	Temp. Output	Energized	Deenergized	Delay protecting
	Defrost	Defrosting	Not defrosting	Dripping water
	Mode	Cooling mode	----	----
	Mode	Heating mode	----	----
	Maintenance	Need maintenance	No failure found	----
	Warning	Has warning	No warning	----

### 5.2 Digital Display

Four digits display values in normal condition. They also display warnings as below:

Warning Code	Remark
E01	Room sensor failure (short or open)
E02	Pipe sensor failure (short or open)
Hi	Room temp. Is higher than the high limit
Lo	Room temp. Is lower than the low limit
EE	Memory error
Err	Password error
iA	External warning
dEF	Defrosting
UnL	Will restore to factory default settings. For example, the password will be "1111"

### 5.3 Set Set-Point

Keep [S] depressed for 3 seconds to enter into the status. Press [▲] or [▼] to set the value (keeping depressed can fast set).

Press [S] to exit, and save the settings.

The status will exit, and the settings will not be saved, if no key operation within 30 seconds.

### 5.4 Set Parameters

Password:

Keep [P] depressed for 3 seconds, digits show "--0". Press [▼] to select the digit of the password, press [▲] to set the value of the digit, press [S] to confirm. If the password is correct, enter into the parameter setting status, else display "Err", and exit.

Parameter Set:

The display will show "U10". Press [▲] or [▼] to select the parameter code (see table below), press [S] to display the value of the code, press [▲] or [▼] to set its value, press [S] to return.

Keep [P] depressed for 3 seconds to exit, and save the settings.

The status will exit, and the settings will not be saved, if no key operation for 30 seconds.

**Parameter Code Table**

Code	Function	Range	Remark	Factory default	ZL-610A	ZL-620A	ZL-630A	
U10	Temp. output stop protection time	0~100 min		3	●	●	●	
U11	Temp. output run protection time	0~100 min		3	●	●	●	
U12	Temp. output run frequency	0~8	Only for cooling mode, 0 = disable	5	●	●	●	
U20	Room sensor calibration	-9.9~+9.9°C		0	●	●	●	
U21	Pipe sensor calibration	-9.9~+9.9°C	di = disable pipe sensor (also disable defrost function)	0	/	●	●	
		di						
U22	Hysteresis	0.1~+10.0°C	See paragraph 6.1 and 6.2	1	●	●	●	
U30	Defrost period	0~180 hour	0 = disable defrost	12	●	●	●	
U31	Defrost time	1~180 min		30	●	●	●	
U32	Defrost finish temp.	0.5~50°C		15	/	●	●	
U33	Dripping time	0~180 min		5	●	●	●	
U34	Over temp. warning delay after defrost	0~180 hour	0 = disable	2	●	●	●	
U35	Defrost after online	0~1	0 = disable, 1 = enable	0	●	●	●	
U36	Delay for <i>defrost after online</i>	0~180 min	0 = disable	0	●	●	●	
U38	Defrost type	0~1	0 = Electrical, 1 = Gas or pump	0	/	●	●	
U40	Fan start temp.	-45~+120°C		-10	/	/	●	
U41	Fan start delay	0~600 sec		60	/	/	●	
U42	Fan stop delay	0~600 sec		0	/	/	●	
U43	Fan control mode	0~1	0 = controlled, 1 = free	0	/	/	●	
U50	Deviation for high temp. warning	0~60°C	0 = disable	0	●	●	●	
U51	Deviation for low temp. warning	0~60°C	0 = disable	0	●	●	●	
U52	Over temp. warning delay	0~180 min		30	●	●	●	
U53	Over temp. warning delay after online	0~180 hour	0 = disable	2	●	●	●	
U60	External warning input mode	0~4	0 = disable	0	●	●	●	
			1 = NO, locked					3 = NC, locked
			2 = NO, unlocked					4 = NC, unlocked
U61	External warning delay	0~120 min		0	●	●	●	
U62	Buzzer warning	0~1	0 = disable, 1 = enable	0	●	●	●	
U90	Working mode	CO / HE	CO = cooling, HE = heating	CO	●	●	●	
U91	On/offline	On / OFF		On	●	●	●	
U99	Password	0000 ~ 9999		1111	●	●	●	

## 7. Control Function

### 6.1 Cooling Control

If  $T_{room} \geq \text{Set-point} + U22$ , and **Temp.\_output** has stopped for U10, then **Temp.\_output** energized;  
If  $T_{room} \leq \text{Set-point} - U22$ , and **Temp.\_output** has run for U11, then **Temp.\_output** de-energized.

**Temp.\_output** forced energized

Keep  $\llcorner$  depressed for 5 seconds can force **Temp.\_output** energized under following conditions:

- **Temp.\_output** has de-energized for U10;
- **Troom** is between  $\text{Set-point} + U22$  and  $\text{Set-point} - U22$ ;
- Not in defrosting and dripping status.

The forced energized status will end when **Troom** arrives at  $\text{Set-point} - U22$ .

### 6.2 Heating Control

If  $T_{room} \leq \text{Set-point} - U22$ , and **Temp.\_output** has stopped for U10, then **Temp.\_output** energized;  
If  $T_{room} \geq \text{Set-point} + U22$ , and **Temp.\_output** has run for U11, then **Temp.\_output** de-energized.

**Temp.\_output** forced energized

Keep  $\llcorner$  depressed for 5 seconds can force **Temp.\_output** energized under following conditions:

- **Temp.\_output** has de-energized for U10;
- **Troom** is between  $\text{Set-point} + U22$  and  $\text{Set-point} - U22$ ;

The forced energized status will end when **Troom** arrives at  $\text{Set-point} + U22$ .

### 6.3 Temp.\_output delay protection

After power supply, **Temp.\_output** could be energized after U10;

After **Temp.\_output** de-energized, it could be energized again after U10;

After **Temp.\_output** energized, it could be de-energized after U11.

### 6.4 Fan Control Mode (for ZL-630A)

**Controlled Mode** (U43 = 0)

When cooling, if  $T_{pipe} \leq U40$ , and **Temp.\_output** has run for U41, fan energized;

If U41 = 0, fan will be energized right after the **Temp.\_output** energized.

After **Temp.\_output** has de-energized for U42, fan de-energized.

If U42 = 0, fan will be de-energized right after the **Temp.\_output** de-energized.

**Free Mode** (U43 = 1)

Fan will always be energized, except during defrosting.

U40, U41 and U42 have no function in this mode.

### 6.5 Protecting Run When Room Sensor Fails (for Cooling Mode)

When room sensor fails, **Temp.\_output** will be energized and de-energized periodically.

For every 30 minutes, **Temp.\_output** will be energized for  $T_{run} = U12 * 3$  minutes, de-energized for  $(30 - T_{run})$  minutes.

## 6.6 Run When Pipe Sensor Fails

When pipe sensor fails, the defrost function will be canceled (for ZL-620A and ZL-630A).

When pipe sensor fails, and the fan works in controlled mode, fan will be only works according to U41 and U42 (for ZL-630A).

## 6.7 Defrost (for Cooling Mode)

**Defrost Start:** After c energized for U30, and  $T_{\text{pipe}} \leq U32$ , defrost starts.

**Defrost End:** When  $T_{\text{pipe}} \geq U32$ , or the defrosting has lasted for U31, defrost ends.

Note: for ZL-610A, only acts according to U30 and U31.

**Electrical Defrost (U38 = 0):** during defrost, **Temp.\_output** de-energized, defrost relay energized.

**Gas or Pump Defrost (U38 = 1):** during defrost, **Temp.\_output** energized, defrost relay energized.

### Manually Forced Defrost:

During none-defrost status, keeping [▲] depressed for 7 seconds will start forced defrost;

During defrost status, keeping [▲] depressed for 7 seconds will stop forced defrost;

**Dripping Water:** after defrost finished, the device will be dripping for U33, then start cooling again.

Note: No dripping function: when the manual forced defrost finished, or when the pipe sensor fails.

### Check for $T_{\text{pipe}}$ , Left Time of Defrosting, Left Time of Dripping Water:

When Troom displayed, press [▲] will show  $T_{\text{pipe}}$ . ZL-610A has not this function

Attention: when this key is depressed for 7 seconds, it will start forced defrost.

When defrosting, press [▼] will show the left time of defrost.

When dripping, press [▼] will show the left time of dripping.

## 8. Buzzer

Every press of key, there will be a short beep. Every confirmation press, there will be a long beep.

Every error operation, there will be three short beeps.

When the device has failure, or external warning input:

If U62 = 0, no buzzing warning.

If U62 = 1, there will be continuous buzzing for warning.

Press [P] can stop warning, if warning condition disappears.

## 9. Over Temp. Warning

When  $T_{\text{room}} \geq \text{Set-point} + U50$ , there will be warning if the following condition meets:

$U50 > 0$  (U50 is not set to 0):

If power just supplied, U53 has passed;

If defrost just finished, U34 has passed;

The Troom keeps up condition for U52.

When  $Troom \leq \text{Set-point} - U51$ , there will be warning if the following condition meets:

- U51 > 0 (U50 is not set to 0);
- If power just supplied, U53 has passed;
- If defrost just finished, U34 has passed;
- The Troom keeps up condition for U52.

### 10. External Warning Input

NO: normal open. If open, no warning; if closed, warning.  
 NC: normal close. If closed, no warning; if open, warning.  
 Locked: Warning keeps after the external warning disappeared. Press **[P]** to stop warning.  
 Unlocked: Warning stops after the external warning disappeared.

**Note: When there is external warning, the outputs de-energized.**

### 11. Sensor Calibration

The room sensor and pipe sensor can be calibrated by U20 and U21.

### 12. Restore To Factory Default Settings

Keep **[P]** and **[▲]** depressed simultaneously for 5 sec, there will be a short beep, and “UnL” displays.  
 Press **[▼]** twice, there will be a beep, all setting will be restored to factory default settings.

### 13. Checking Controller Information

Keep **[S]** and **[▲]** depressed simultaneously for 5 sec, the controller’s model and version will display.

### 14. Installation

#### Warning!

Avoid to install controller in the following environment:

- More wet than 90%RH, or easily dew;
- Vibrating, or be shocked;
- Possible sprayed;
- Under erosive air;
- Under explosive air.



#### Installation

1<sup>st</sup>: Insert into drilling hole

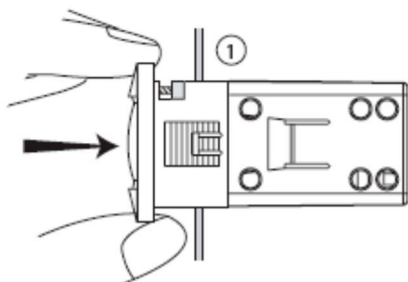

2<sup>nd</sup>: Clamp

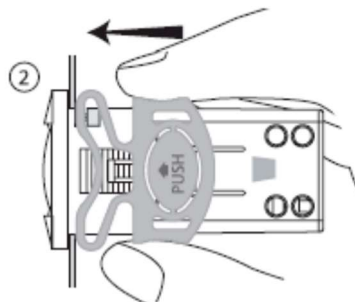

### 15. Electrical Wiring

#### Warning!

- Wiring work should be manipulated by certified technicians;
- Supplied power should within specification requirement;
- Sensor and input signal bundles should not be laid together with power supply bundles, in same pipe;
- Sensor's bundle is better as short as possible. Not wind the redundant length bundle to electrical noise equipment.
- Don't touch inside components;
- Equip safety devices for equipment for equipment protection and human safety. Before supply power, check wiring again.



#### Electrical Wiring

